

Digital I/O board, optically isolated, 32 digital inputs and outputs, 24 V, for CompactPCI Serial

NEW*

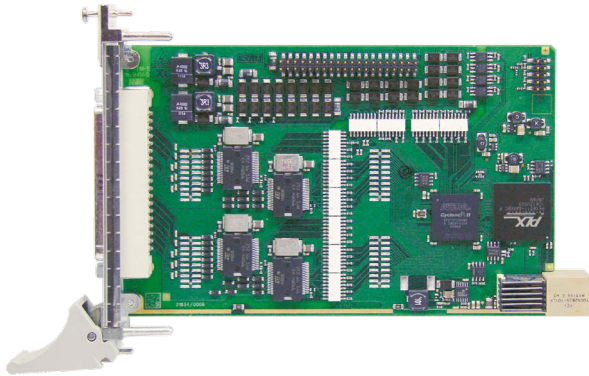

CPCIs-1532

CompactPCI Serial interface

16 digital inputs, 24 V,
including 15 interruptible inputs

16 digital outputs, 24 V, 500 mA/channel

Optical isolation 1000 V

Input and output filters

Connection through industry-standard
D-Sub connector

Extended temperature range -40 °C to +85 °C



Also for **PCI EXPRESS**
See APCIe-1532, page 118

Also for **PCI**
See APCI-1500, page 146

Also for **CompactPCI™**
See CPCI-1500, page 230

Also for **PC/104-PLUS**
see PC104-PLUS1500
page 214



* Preliminary
product information

Features

Inputs

- 16 optically isolated inputs, 24 V incl. 15 interruptible inputs
- Channel 0 can be used as a 16-bit counter input (up to 100 kHz)
- Reverse voltage protection
- All inputs are filtered

Outputs

- 16 optically isolated outputs, 11 to 36 V
- Output current per channel 500 mA
- Total current: 3 A typ. (fused through PTC resistor)
- Watchdog for resetting the outputs to "0"
- At Power-On, reset of the outputs to "0"
- Current limit: ~1.5 A per 8 channels (through PTC)
- Short-circuit current per output ~1.5 A typ.
- Self-resetting fuse (electronic fuse)
- Overtemperature and overvoltage protection
- 24 V power outputs with protection diodes and filters
- Ext. 24 V voltage supply screened and filtered
- Shutdown logic, when the external supply voltage drops below 7 V

Timer / Counter

- 2 timers (12-bit resolution)
- 1 timer can be used as watchdog

Safety features

- Optical isolation 1000 V
- Creeping distance IEC 61010-1
- Protection against fast transients (burst), overvoltage, electrostatic discharge and high-frequency EMI
- Separate ground line for inputs and outputs

Protective circuit for the input channels

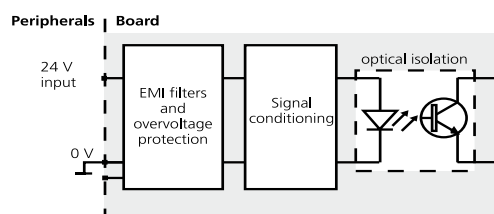

Applications

- Industrial I/O control
- PLC coupling
- Reading of encoder values for process control
- Signal switching
- Interface to electromechanical relays
- ON/OFF monitoring of motors, lights...
- Watchdog / timer
- Interface to machines

Software drivers

A CD-ROM with the following software and programming samples is supplied with the board.

Standard drivers for:

- Linux
- 32-bit drivers for Windows 8 / 7 / Vista / XP / 2000
- Signed 64-bit drivers for Windows 8 / 7 / XP
- Real-time use with Linux and Windows on request

Drivers and samples for the following compilers and software packages:

- MC .NET, C

On request:

Further operating systems, compilers and samples.

Driver download: www.addi-data.com/downloads

Protective circuit for the output channels

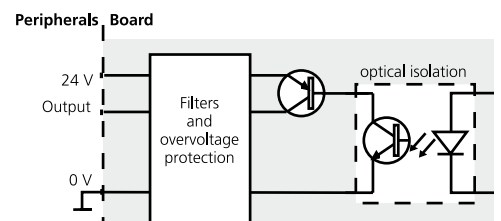

Specifications*

Digital inputs

Number of inputs:	16 digital inputs, channel 0 can be used as a 16-bit counter input (up to 100 kHz)	
Interruptible inputs:	15 channels (channel 1 to 15)	
Optical isolation:	1000 V through opto-couplers, from PC to peripheral	
Nominal voltage:	24 V (CPCIs-1532), 12 V (CPCIs-1532-12V)	
Input current:	at 24 V	at 12 V (CPCIs-1532-12V)
Channel 0 or 0-1:	6.6 mA typ.	3.2 mA typ.
Channel 1-15 or 2-16:	2 mA typ.	1.5 mA typ.
Input frequency (max.):	at 24 V	at 12 V (CPCIs-1532-12V)
Channel 0 or 0-1:	100 kHz	100 kHz
Channel 1-15 or 2-16:	5 kHz	5 kHz
Logic input levels:	at 24 V	at 12 V (CPCIs-1532-12V)
UH (max.):	30 V	16 V
UH (min.):	19 V	9 V
UL (max.):	14 V	6 V
UL (min.):	0 V	0 V
Filters/protective circuit:	Input filters, transil diode, RC filters, Z diode, opto-couplers	

Digital outputs

Number of outputs:	16 digital outputs	
Output type:	High-side (load to ground) acc. to IEC 1131-2	
Optical isolation:	1000 V (through opto-couplers), from PC to peripheral	
Nominal voltage:	24 V	
Supply voltage range:	11 to 36 V	
Current limit:	1.5 A per 8 channels (through PTC)	
Output current per output:	500 mA (typical)	
Short-circuit current per output:	1.5 A (typ.) pulse current shutdown at 24 V, $R_{load} < 0.1 \Omega$	
RDS ON resistance:	max. 0.2 Ω at 25 °C	
Switch-on time:	$t_{out} = 0.5 A, load = resistance: 50 \mu s$	
Switch-off time:	$t_{out} = 0.5 A, load = resistance: 75 \mu s$	
Overtemperature (shutdown):	135 °C (output driver)	
Temperature hysteresis:	15 °C (output driver)	

Timer/watchdog

Timer:	2 x 12-bit timers, 1 up to 4095 μs , ms, s 1 timer can be used as watchdog.
--------	---

Safety

Shutdown logic (V_{CC} diagnostic):	When the ext. 24 V voltage drops below 7 V: The outputs are switched off.
Watchdog:	For resetting the outputs to "0"
Common diagnostics:	For all 16 channels at overtemperature of one channel

EMC – Electromagnetic compatibility

The product complies with the European EMC directive. The tests were carried out by a certified EMC laboratory in accordance with the norm from the EN 61326 series (IEC 61326). The limit values as set out by the European EMC directive for an industrial environment are complied with. The respective EMC test report is available on request.

Physical and environmental conditions

Dimensions:	149 x 99 mm	
System bus:	PCI Express according CompactPCI Serial specification PICMG CPCI-S.0 R1.0	
Space required:	1 x CompactPCI Serial slot	
Operating voltage:	+3.3 V from PC	
Current consumption:	Inputs/outputs inactive	320 mA \pm 10 %, typ.
	8 inputs/outputs active	400 mA \pm 10 %, typ.
	16 inputs/outputs active	470 mA \pm 10 %, typ.
Front connector:	37-pin D-Sub male connector	
Temperature range:	from -40°C to +85 °C	

CPCIs-1532

Digital I/O board, optically isolated, 32 digital inputs and outputs, 24 V, for CompactPCI Serial. Incl. technical description and software drivers.

CPCIs-1532: 16 inputs, 24 V, 16 outputs, 11-36 V, 1 counter

Accessories

- PX901-D:** Screw terminal panel, LED status display
- PX901-DG:** Screw terminal panel, LED status display, for DIN rail
- PX9000:** 3-row screw terminal panel for DIN rail, with LED status display
- PX8500-G:** Relay output board for DIN rail, cascadable

Simplified block diagram

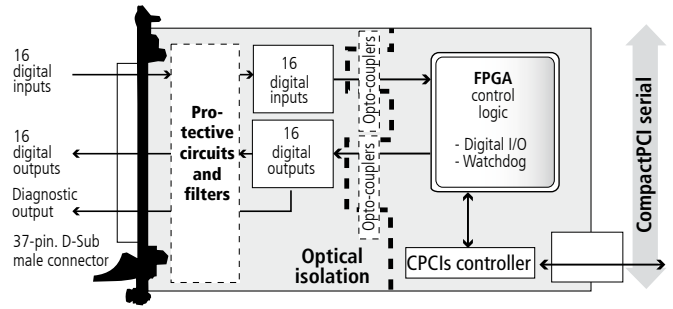

Pin assignment – 37-pin D-Sub male connector

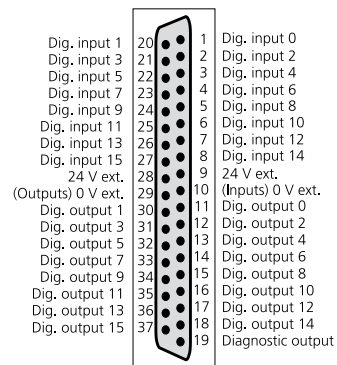

ADDI-DATA connection

Example 1
Connection of the inputs and outputs through screw terminal panel

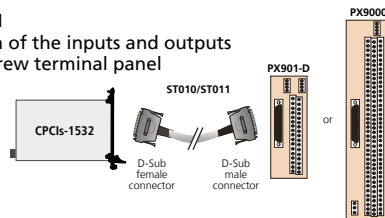

Example 2
Connection of the inputs through screw terminal panel PX901-DG
Connection of the outputs through relay output board PX8500-G

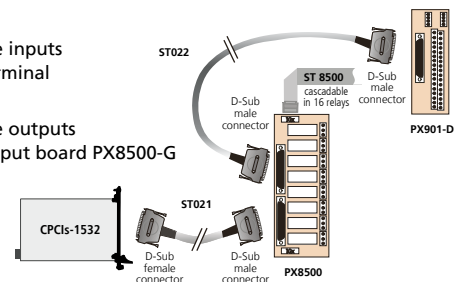

Ordering information

- ST010:** Standard round cable, shielded, twisted pairs, 2 m
- ST011:** Standard round cable, shielded, twisted pairs, 5 m
- ST010-S:** Same as ST010, for high currents
- ST021:** Round cable between APCL-15x2 and PX8500-G, shielded, twisted pairs, 2 m
- ST022:** Round cable between PX8500-G and PX901 or PX9000, shielded, 2 m
- ST8500:** Ribbon cable for cascading two PX8500-G

*Preliminary product information