

# Digital output board, optically isolated, 32 digital outputs, 24 V / 5 V

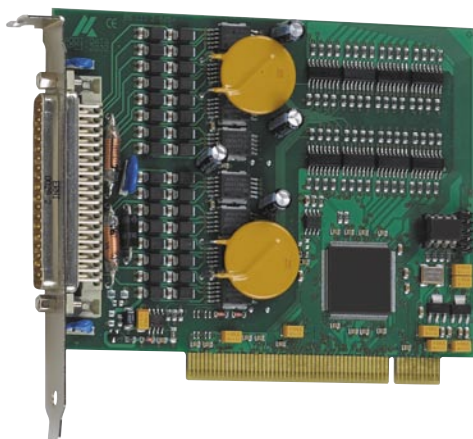

## APCI-2032 / APCI-2032-5

32 digital outputs, 24 V or 5 V,  
500 mA/channel

Optical isolation 1000 V

Output filters, short-circuit protection

Watchdog

The outputs are reset to "0"  
at Power-On

### Features

- 32 digital outputs, 24 V (APCI-2032) or as 5 V version (APCI-2032-5), optically isolated
- Output current per channel: 500 mA
- Voltage range: 10 V to 36 V
- Diagnostic report, through status register at short-circuits, overtemperature, voltage drop or watchdog
- Programmable watchdog for resetting the outputs to "0", function release through software
- Interrupt triggered through error
- At Power-On the outputs are reset to „0“

### Safety features

- Optical isolation 1000 V
- Creeping distance IEC 61010-1
- Protection against fast transients (burst), overvoltage, electrostatic discharge and high-frequency EMI
- Maximum output current for 32 outputs 6 A typ. (2 x 3 A)
- 24 V power outputs with protection diodes and filters
- Self-resetting fuse (electronic fuse)
- Short-circuit current per output 1.5 A typ.
- Output capacitors against electromagnetic emissions
- Fast demagnetisation in case of inductive loads
- External 24 V voltage supply screened and filtered

### Applications

- Signal switching
- Interface to electromechanical relays
- Automatic test equipment
- ON/OFF monitoring of motors, lights...
- Watchdog timer • Machine interfacing

### Connection principle of the outputs at 24 V (APCI-2032) and 5 V (APCI-2032-5)

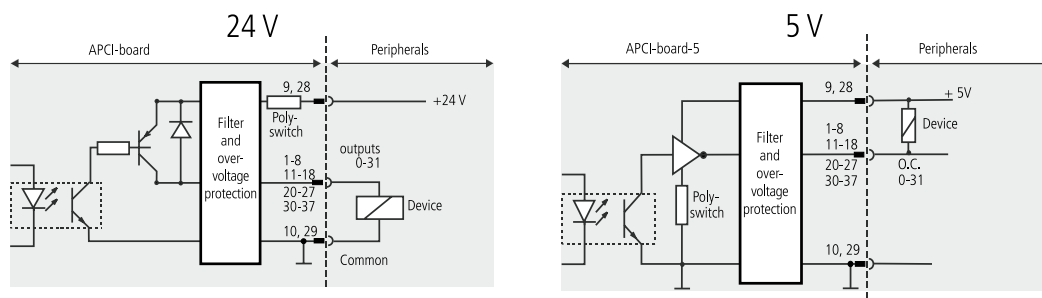

### Software drivers

A CD-ROM with the following software and programming samples is supplied with the board.

#### Standard drivers for:

- Linux
- 32-bit drivers for Windows 8 / 7 / Vista / XP / 2000
- Signed 64-bit drivers for Windows 8 / 7 / XP
- Real-time use with Linux and Windows on request

#### Drivers and samples for the following compilers and software packages:

- .NET
- Microsoft VC++ • Borland C++
- Visual Basic • Delphi
- LabVIEW • LabWindows/CVI • DIAdem

#### ADDIPACK functions:

Digital output • Watchdog

#### On request:

Further operating systems, compilers and samples.

Driver download: [www.addi-data.com/downloads](http://www.addi-data.com/downloads)



PCI 32-bit



Signed 64-bit drivers  
for Windows 7/Vista/XP



LabVIEW™



LabWindows/CVI™



## Specifications

### Digital outputs

Outputs:	32
Output type:	High-side (load to ground) acc. to IEC 1131-2
Optical isolation:	through opto-couplers, 1000 V from PC to peripheral
Nominal voltage:	24 V (APCI-2032); or 5 V (APCI-2032-5)
Supply voltage:	for 24 V version: 10 V to 36 V for 5 V version: 5 V to 12 V via front connector
Max. current for 32 outputs:	6 A typ. (2x3 A)
Output current:	500 mA max./channel
Short-circuit current/output shutdown at 24 V, $R_{load} < 0.1 \Omega$ :	1.5 A
RDS ON resistance:	0.4 $\Omega$ max.
Switch-on time:	$I_{out}=0.5 A, load = resistance: 94 \mu s$ typ. (APCI-2032) $I_{out}=50 mA, load = resistance: 250 \mu s$ typ. (APCI-2032-5V)
Switch-off time:	$I_{out}=0.5 A, load = resistance: 8 \mu s$ typ. (APCI-2032) $I_{out}=50 mA, load = resistance: 3 \mu s$ typ. (APCI-2032-5V)
Overtemperature (shutdown):	170 °C (output driver)
Temperature hysteresis:	20 °C (output driver)

### Safety

Shut-down logic ( $V_{CC}$  diagnostic): If the ext. 24 V voltage drops below 5 V, then the outputs are switched off.

CC-Diagnostics: Pin 19: status bit or interrupt to the PC

Watchdog: 8-bit, programmable, 20 ms up to 5 s in steps of 20 ms

### EMC – Electromagnetic compatibility

The product complies with the European EMC directive. The tests were carried out by a certified EMC laboratory in accordance with the norm from the EN 61326 series (IEC 61326). The limit values as set out by the European EMC directive for an industrial environment are complied with. The respective EMC test report is available on request.

### Physical and environmental conditions

Dimensions:	131 x 99 mm
System bus:	PCI 32-bit 5 V acc. to specification 2.1 (PCISIG)
Space required:	1 PCI slot
Operating voltage:	+5 V, $\pm 5\%$ from the PC
Current consumption:	230 mA $\pm 10\%$ typ.
Front connector:	37-pin D-Sub male connector
Temperature range:	0 to 60 °C (with forced cooling)

Screw terminal panel PX901-DG with cable ST010



Relay output board PX8500-G

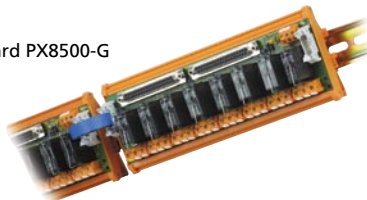

### Simplified block diagram

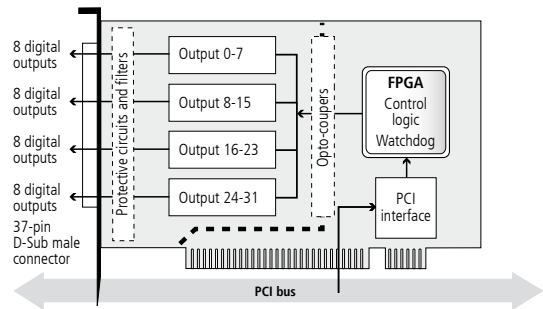

### Pin assignment – 37-pin D-Sub male connector

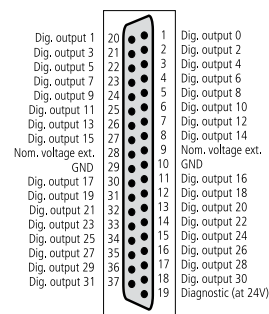

### ADDI-DATA connection

**Example 1**  
Connection of the outputs through screw terminal panels

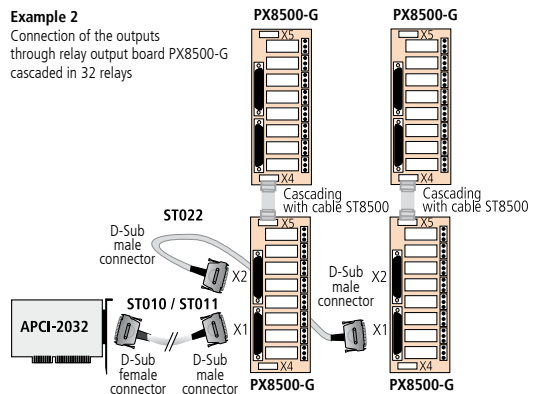
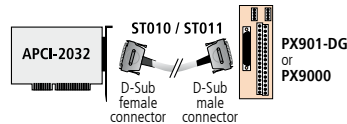

### Ordering information

#### APCI-2032 /APCI-2032-5

**APCI-2032:** Digital output board, optically isolated, 32 digital outputs, 24 V. Incl. technical description and software drivers

**APCI-2032-5:** Digital output board, optically isolated, 32 digital outputs, 5 V. Incl. technical description and software drivers

#### Accessories

**PX901-D:** Screw terminal panel, LED status display

**PX901-DG:** Same as PX901-D, for DIN rail

**PX 901-ZG:** Screw terminal panel (only APCI-2032-5)

**PX9000:** 3-row screw terminal panel for DIN rail, LED status display

**PX8500-G:** Relay output board for DIN rail, cascable

**ST010:** Standard round cable, shielded, twisted pairs, 2 m

**ST011:** Standard round cable, shielded, twisted pairs, 5 m

**ST010-S:** Same as ST010, for high currents (24 V supply separate)

**ST022:** Round cable between two PX8500-G, shielded, 2 m

**ST8500:** Ribbon cable for cascading two PX8500-G