

Digital I/O board, optically isolated, 32 digital inputs and outputs, 24 V / 12 V, for PCI Express

New!*

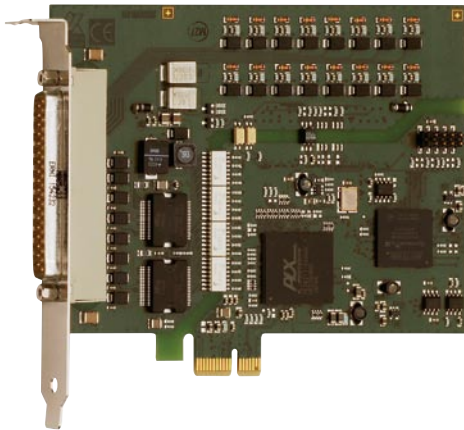

Also for PCI
See APCI-1500, page 146

Also for CompactPCI™
See CPCI-1500, page 230

Also for CompactPCI® Serial
See CPCIs-1532, page 218

Also for PC/104-PLUS
see PC104-PLUS1500, page 214



LabWindows/CVI™

DASYLab 10
Data Acquisition System Laboratory



*Preliminary
product information

Features

- 3 programmable timers
- Connector and software compatible to the digital I/O boards APCI-1500 for the PCI bus and CPCI-1500 for the CompactPCI bus.
- Connector compatible to the ISA board PA 1500.
- Monitoring program for testing and setting the board functions

Inputs

- 16 optically isolated digital inputs, 24 V or 12 V (APCLe-1500-12V), including 14 interruptible inputs
- Reverse voltage protection
- All inputs are filtered

Outputs

- 16 optically isolated digital outputs, 10 V to 36 V
- Output current per channel 500 mA
- Timer programmable watchdog for resetting the outputs to „0“
- Diagnostic report through status register at short-circuits, overtemperature, voltage drop or watchdog
- Interrupt triggered through watchdog, timer, error
- At Power-On, reset of the outputs to „0“
- Short-circuit current for 16 outputs ~ 3 A typ.
- Short-circuit current per output ~1.5 A typ.
- Self-resetting fuse (electronic fuse)
- Overtemperature and overvoltage protection
- 24 V power outputs with protection diodes and filters
- Output capacitors against electromagnetic emissions
- External 24 V voltage supply screened and filtered
- Shutdown logic, when the external supply voltage drops below 5 V

Safety features

- Optical isolation 1000 V
- Creeping distance IEC 61010-1

Protective circuit for the input channels

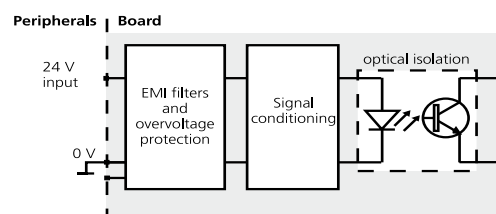

APCLe-1500 / APCLe-1500-12V

16 digital inputs, 24 V or 12 V,
including 14 interruptible inputs

16 digital outputs, 10-36 V, 500 mA/channel

Optical isolation 1000 V

Input and output filters

Watchdog, timer

At Power-On the outputs are reset to "0"

- Protection against fast transients (burst), overvoltage, electrostatic discharge and high-frequency EMI
- Separate ground lines for inputs and outputs

Applications

- Industrial I/O control
- PLC coupling
- Reading of encoder values for process control
- Signal switching
- Interface to electromechanical relays
- ON/OFF monitoring of motors, lights...
- Watchdog timer • Interface to machines

Software drivers

A CD-ROM with the following software and programming samples is supplied with the board.

Standard drivers for:

- Linux
- 32-bit drivers for Windows 8 / 7 / Vista / XP / 2000
- Signed 64-bit drivers for Windows 8 / 7 / XP
- Real-time use with Linux and Windows on request
- RTX drivers (real-time)

Drivers and samples for the following compilers and software packages:

- .NET
- Microsoft VC++ • Borland C++
- Visual Basic • Delphi
- LabVIEW • LabWindows/CVI

On request:

Further operating systems, compilers and samples.

Driver download: www.addi-data.com/downloads

Protective circuit for the output channels

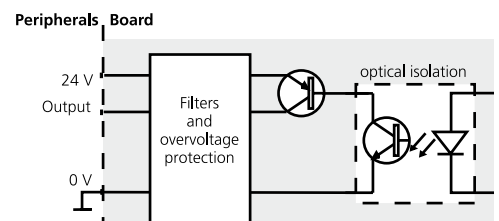

Specifications*

Digital inputs

Number of inputs:	16 (common ground acc. to IEC 1131-2)
Including interruptible inputs:	14, IRQ line selected through BIOS
Optical isolation:	Through opto-couplers, 1000 V from PC to peripheral
Compare logic:	AND and OR mode; OR priority

24 V version (APcLe-1500)

Nominal voltage:	24 V
Input current at 24 V:	6 mA typ.
Logic input levels:	U nominal: 24 V
UH max.:	30 V/current 9 mA typ.
UH min.:	19 V/current 2 mA typ.
UL max.:	14 V/current 0.7 mA typ.
UL min.:	0 V/current 0 mA typ.
Signal delay:	70 µs (at nominal voltage)
Maximum input frequency:	5 kHz (at nominal voltage)

12 V version (APcLe-1500-12V)

Nominal voltage:	12 V
Input current at 12 V:	4.2 mA typ.
Logic input levels:	U nominal: 12 V
UH max.:	16 V/current 6.3 mA typ.
UH min.:	9 V/current 2.7 mA typ.
UL max.:	6 V/current 1.2 mA typ.
UL min.:	0 V/current 0 mA typ.
Signal delay:	70 µs (at nominal voltage)
Maximum input frequency:	5 kHz (at nominal voltage)

Digital outputs

Number of outputs:	16, optically isolated up to 1000 V through opto-couplers
Output type:	High-side (load to ground) acc. to IEC 1131-2
Nominal voltage:	24 V / 12 V (APcLe-1500-12V)
Supply voltage:	10 V to 36 V, min. 5 V (via front connector)
Max. current for 16 outputs:	3 A typ.
Output current/output:	500 mA max.
Short-circuit current/output shutdown at 24 V, $R_{load} < 0.1 \Omega$:	1.5 A
RDS ON resistance:	0.4 Ω max.
Switch-on time:	I _{out} =0.5 A, load = resistance: 100 µs
Switch-off time:	I _{out} =0.5 A, load = resistance: 60 µs
Overtemperature (shutdown):	170 °C (output driver)
Temperature hysteresis:	20 °C (output driver)

Safety

Shutdown logic:	When the ext. 24 V voltage drops below 5 V: The outputs are switched off.
Diagnostics:	Status bit or interrupt to the PC
Timer:	3
Watchdog:	Timer-programmable, 10 µs to 37 s

EMC – Electromagnetic compatibility

The product complies with the European EMC directive. The tests were carried out by a certified EMC laboratory in accordance with the norm from the EN 61326 series (IEC 61326). The limit values as set out by the European EMC directive for an industrial environment are complied with. The respective EMC test report is available on request.

Physical and environmental conditions

Dimensions:	149 x 99 mm
System bus:	Acc. to PCI Express base specification, Revision 1.0a (PCI Express 1.0a)
Space required:	1-/4-lane PCI Express slot
Operating voltage:	+ 3.3 V from PC
Current consumption:	400 mA ± 10 %, typical
Front connector:	37-pin D-Sub male connector
Temperature range:	0 to 60 °C (with forced cooling)

Simplified block diagram

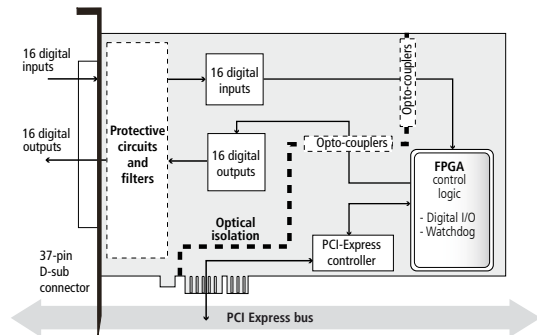

Pin assignment – 37-pin D-Sub male connector

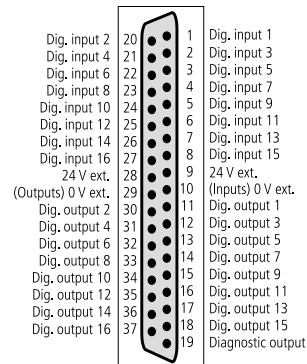

ADDI-DATA connection

Example 1

Connection of the inputs and outputs through screw terminal panels

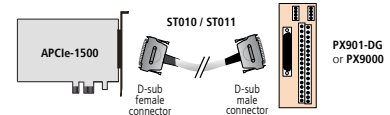

Example 2

- Connection of the inputs through PX901-DG screw terminal panels
- Connection of the outputs through PX8500-G relay output board cascaded in 16 relays

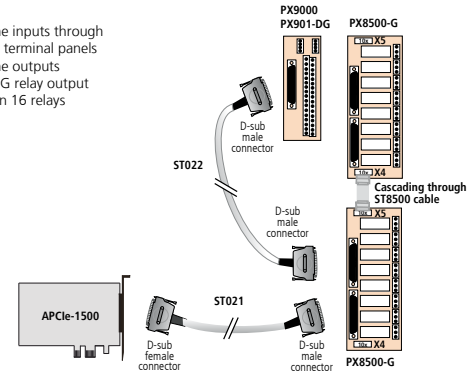

Ordering information

APcLe-1500 / APcLe-1500-12V

Digital I/O board, optically isolated, 32 digital inputs and outputs, 24 V / 12 V, for PCI Express. Incl. technical description and software drivers.

Versions

APcLe-1500: Digital I/O board, opt. isolated, 32 dig. I/O, 24 V inputs, outputs 10 to 36 V

APcLe-1500-12V: Digital I/O board, opt. isolated, 32 dig. I/O, 12 V inputs, outputs 10 to 36 V

Accessories

PX901-D:	Screw terminal panel, LED status display
PX901-DG:	Screw terminal panel, LED status display, for DIN rail
PX9000:	3-row screw terminal panel for DIN rail, LED status display

PX8500-G:	Relay output board for DIN rail, cascadable
ST010:	Standard round cable, shielded, twisted pairs, 2 m
ST011:	Standard round cable, shielded, twisted pairs, 5 m
ST010-S:	Same as ST010, for high currents (separate 24 V supply)
ST021:	Round cable between APcLe-1500 and PX8500-G, shielded, twisted pairs, 2 m
ST022:	Cable between PX8500-G and PX901-DG, shielded, 2 m
ST8500:	Ribbon cable for cascading two PX 8500

* Preliminary product information